

R&K-QH100-0S

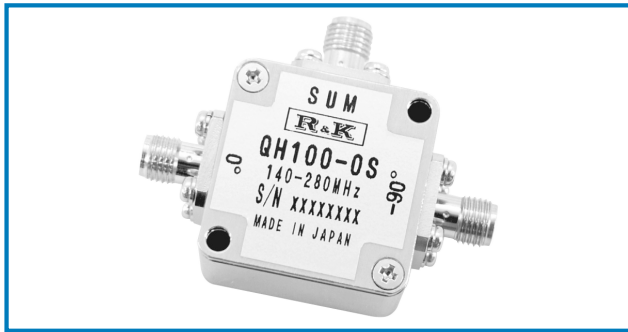

OUTLINE DRAWING

※ IN MILLIMETERS

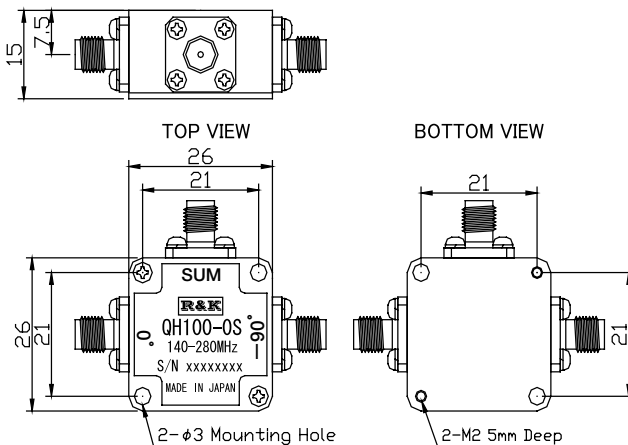

- 2Way-90°
- Frequency Range : 140 ~ 280MHz
- High Isolation
- Low Loss
- RoHS Compliance

SPECIFICATIONS

Frequency Range	: 140 - 280MHz
Insertion Loss	: 0.7dB (max.)
(Except Coupling Loss 3.0dB)	
Amplitude Balance	: 1.5dB (max.)
Isolation	: 18dB (min.)
Phase Balance	: ±5° (max.)
Phase Difference	: 90°
Between Output Ports	
VSWR (All Ports)	: 1.5:1 (max.)
Impedance	: 50 Ω
Maximum RF Input Power	: 1W
Operating Temperature	: -40°C to + 85°C
Storage Temperature	: -40°C to +100°C
Connectors (Standard)	: SMA-FEMALE
Connectors (Option)	: BNC-FEMALE
	: N-FEMALE
Weight (SMA Connector)	: 30g (typ.)

HOW TO ORDER

Model Name	S = SMA - FEMALE
R&K-QH100-0S	B = BNC - FEMALE
	N = N - FEMALE

TYPICAL PERFORMANCE (Temp @+25°C)

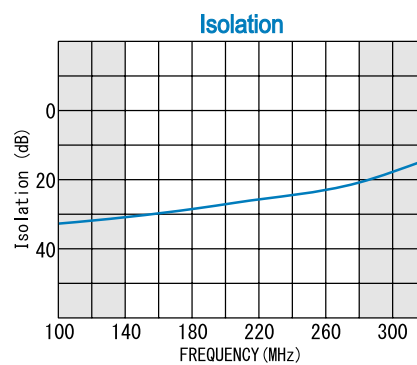
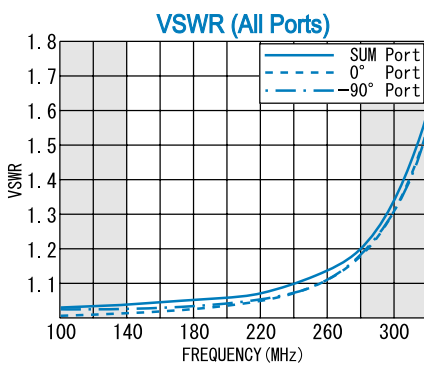

SCHEMATIC

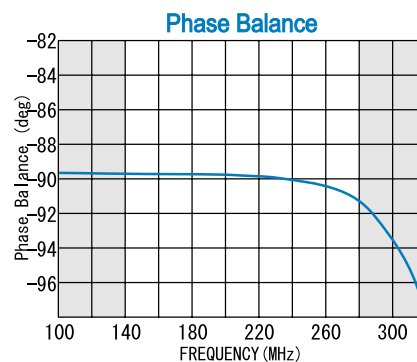
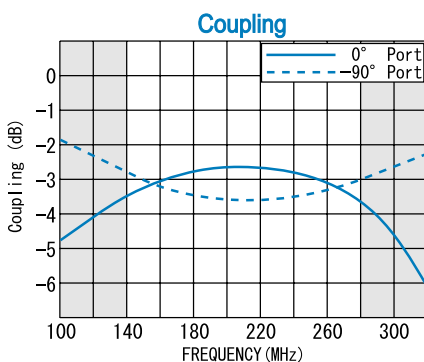
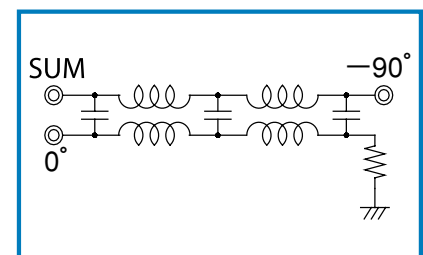

R&K reserves the right to make changes in the specifications of or discontinue products at any time without notice. R&K products shall not be used for or in connection with equipment that requires an extremely high level of reliability and safety such as aerospace uses or medical life support equipment. Further, R&K cannot export products to any country for use in military or defense applications.

R&K Company Limited

721-1 Maeda, Fuji-City, Shizuoka-Pref. 416-8577 Japan
 Tel: +81-545-31-2600 E-mail: info@rkco.jp
 Fax: +81-545-31-1600 URL: http://rk-microwave.com