

# TRIPLE BALANCED MIXER

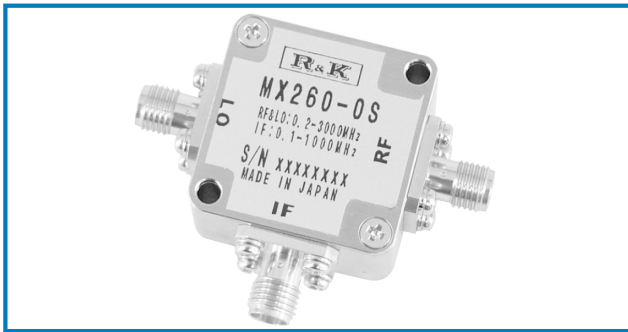

## R&K-MX260-0S



### OUTLINE DRAWING

※IN MILLIMETERS

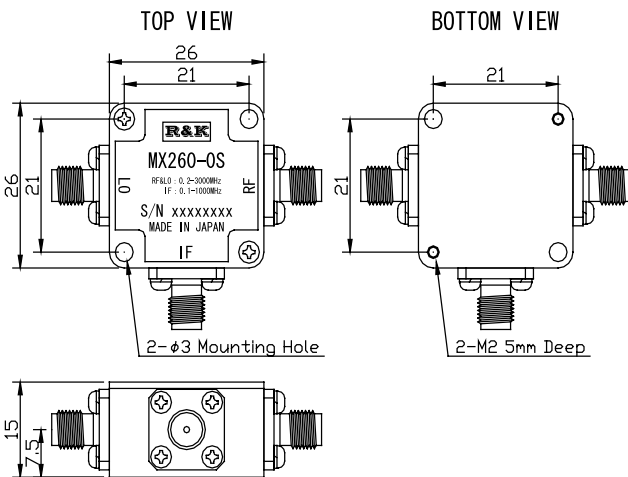

- LO&RF Frequency : 0.2 ~ 3000MHz
- IF Frequency : 0.1 ~ 1000MHz
- Lo Drive Level : +15dBm
- Low Cost
- RoHS Compliance

### SPECIFICATIONS

Frequency Range [LO&RF] : 0.2 - 3000MHz  
 [IF] : 0.1 - 1000MHz  
 Conversion Loss Max. (LO Drive Level +15dBm)

	0.2 - 2MHz	2 - 1500MHz	1500 - 3000MHz
Typ.	6.5dB	6.5dB	7.0dB
Max.	10.0dB	8.5dB	9.5dB

### Isolation (min.)

	0.2 - 2MHz	2 - 1500MHz	1500 - 3000MHz
LO - RF	15dB	20dB	22dB
LO - IF	20dB	25dB	20dB
RF - IF	20dB	25dB	20dB

- Input IP3 @Center Band : +19dBm (typ.)
- Input 1dB Comp. Point : + 9dBm (typ.)
- Impedance (All Ports) : 50 Ω
- Maximum RF Input Power : 200mW
- Maximum Peak IF Current : 50mA
- Operating Temperature : -40°C to + 85°C
- Storage Temperature : -40°C to +100°C
- Connectors (Standard) : SMA-Female
- Connectors (Option) : N-Female
- Weight (SMA Connector) : 30g (typ.)

### HOW TO ORDER

Model Name R&K-MX260-0S

S = SMA - FEMALE  
 N = N - FEMALE

### TYPICAL PERFORMANCE (Temp @+25°C)

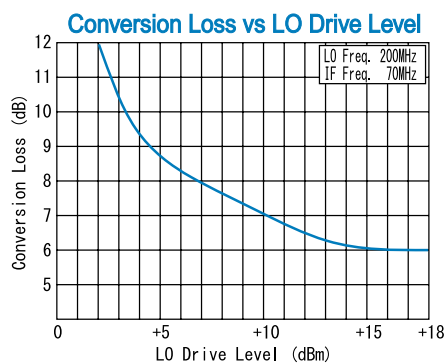
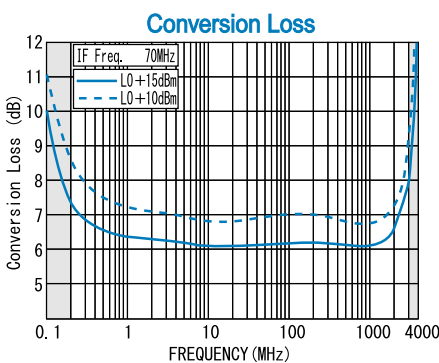

### SCHEMATIC

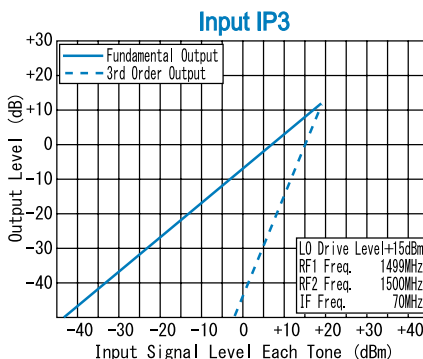
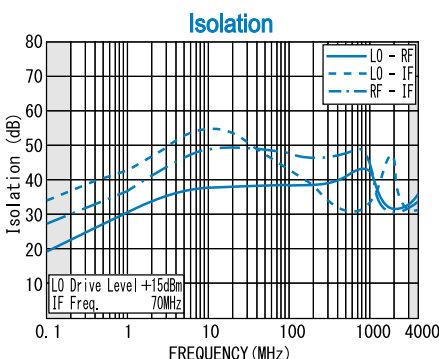
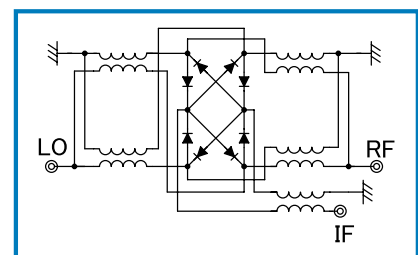

R&K reserves the right to make changes in the specifications of or discontinue products at any time without notice. R&K products shall not be used for or in connection with equipment that requires an extremely high level of reliability and safety such as aerospace uses or medical life support equipment. Further, R&K cannot export products to any country for use in military or defense applications.

## R&K Company Limited

721-1 Maeda, Fuji-City, Shizuoka-Pref. 416-8577 Japan  
 Tel : +81-545-31-2600 E-mail : info@rk.co.jp  
 Fax : +81-545-31-1600 URL : http://rk-microwave.com