

DOUBLE BALANCED MIXER

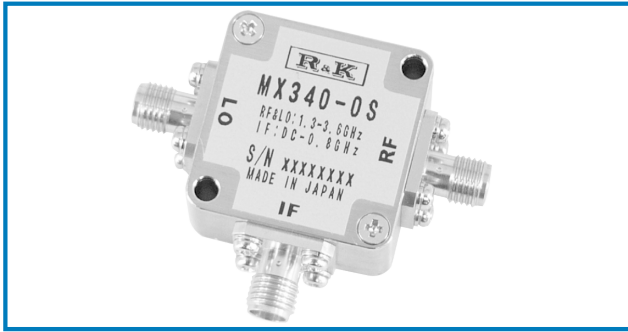

R&K-MX340-0S



OUTLINE DRAWING

※IN MILLIMETERS

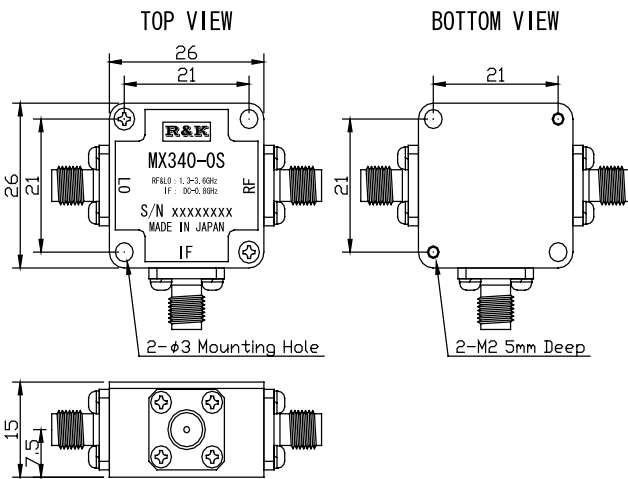

- LO&RF Frequency : 1300~3600MHz
- IF Frequency : DC ~ 800MHz
- Lo Drive Level : +10dBm
- Low Cost
- RoHS Compliance

SPECIFICATIONS

Frequency Range [LO&RF] : 1300 - 3600MHz
 [IF] : DC - 800MHz
 Conversion Loss Max. (LO Drive Level +10dBm)

	1300 - 1800MHz	1800 - 3000MHz	3000 - 3600MHz
Typ.	6.5dB	7.5dB	8.0dB
Max.	9.5dB	10.5dB	12.5dB

Isolation (min.)

	1300 - 1800MHz	1800 - 3000MHz	3000 - 3600MHz
LO - RF	25dB	15dB	12dB
LO - IF	18dB	18dB	15dB
RF - IF	8dB	8dB	8dB

- Input IP3 @Center Band : +16dBm (typ.)
- Input 1dB Comp. Point : + 8dBm (typ.)
- Impedance (All Ports) : 50 Ω
- Maximum RF Input Power : 50mW
- Maximum Peak IF Current : 50mA
- Operating Temperature : -40°C to + 85°C
- Storage Temperature : -40°C to +100°C
- Connectors (Standard) : SMA-Female
- Connectors (Option) : N-Female
- Weight (SMA Connector) : 30g (typ.)

HOW TO ORDER

Model Name R&K-MX340-0S

S = SMA - FEMALE
 N = N - FEMALE

TYPICAL PERFORMANCE (Temp @+25°C)

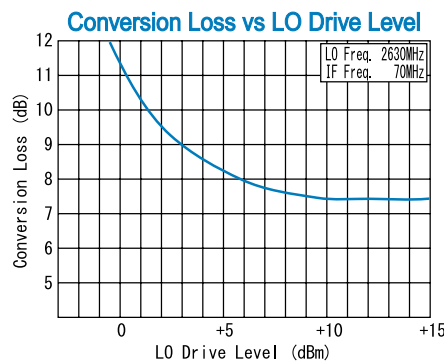
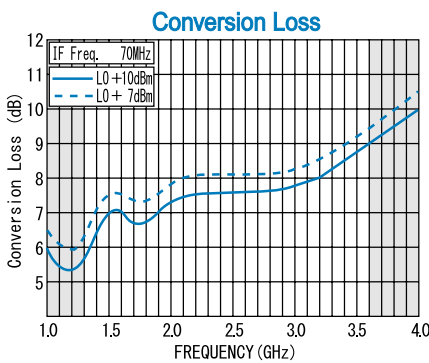

SCHEMATIC

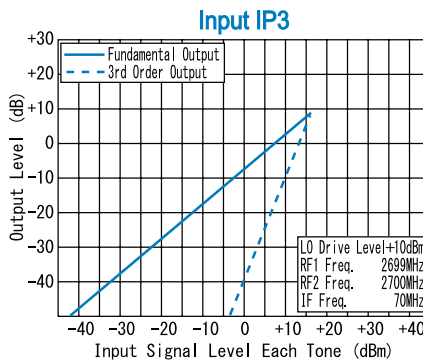
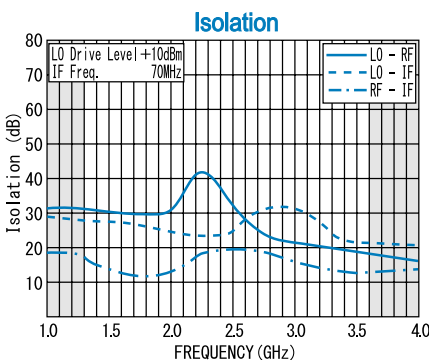
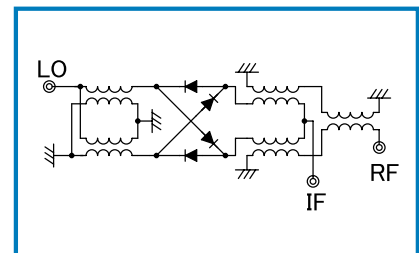

R&K reserves the right to make changes in the specifications of or discontinue products at any time without notice. R&K products shall not be used for or in connection with equipment that requires an extremely high level of reliability and safety such as aerospace uses or medical life support equipment. Further, R&K cannot export products to any country for use in military or defense applications.

R&K Company Limited

721-1 Maeda, Fuji-City, Shizuoka-Pref. 416-8577 Japan
 Tel: +81-545-31-2600 E-mail: info@rk.co.jp
 Fax: +81-545-31-1600 URL: http://rk-microwave.com