

DOUBLE BALANCED MIXER

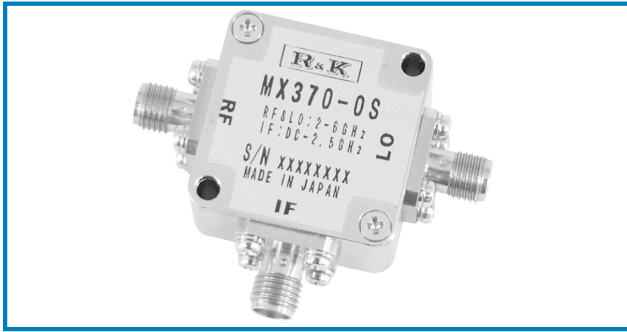

R&K-MX370-0S



OUTLINE DRAWING

※IN MILLIMETERS

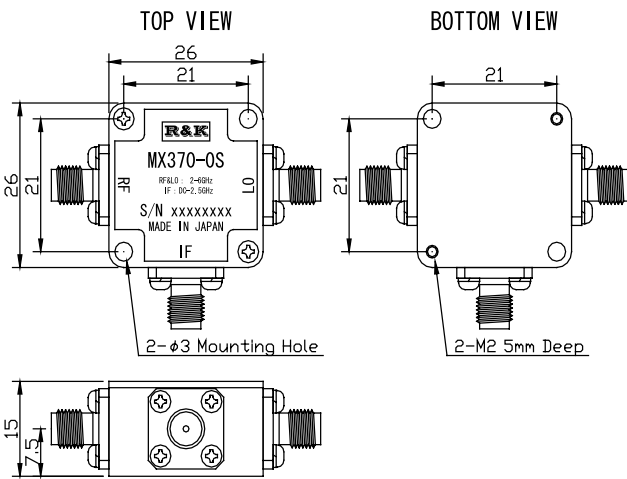

- LO&RF Frequency : 2 ~ 6 GHz
- IF Frequency : DC ~ 2.5GHz
- Lo Drive Level : +7dBm
- Low Cost
- RoHS Compliance

SPECIFICATIONS

Frequency Range [LO&RF] : 2 - 6 GHz
 [IF] : DC - 2.5GHz
 Conversion Loss Max. (LO Drive Level +7dBm)

	2 - 3.5GHz	3.5 - 5GHz	5 - 6GHz
Typ.	6.5dB	8.0dB	8.0dB
Max.	9.0dB	10.0dB	10.5dB

Isolation (min.)

	2 - 3.5GHz	3.5 - 5GHz	5 - 6GHz
LO - RF	15dB	15dB	15dB
LO - IF	10dB	10dB	12dB
RF - IF	5dB	8dB	12dB

- Input IP3 @Center Band : +10dBm (typ.)
- Input 1dB Comp. Point : + 3dBm (typ.)
- Impedance (All Ports) : 50Ω
- Maximum RF Input Power : 50mW
- Maximum Peak IF Current : 50mA
- Operating Temperature : -40°C to + 85°C
- Storage Temperature : -40°C to +100°C
- Connectors : SMA-Female
- Weight : 30g (typ.)

HOW TO ORDER

Model Name
 R&K-MX370-0S No Option

TYPICAL PERFORMANCE (Temp @+25°C)

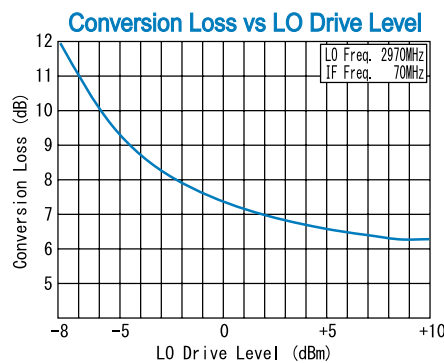
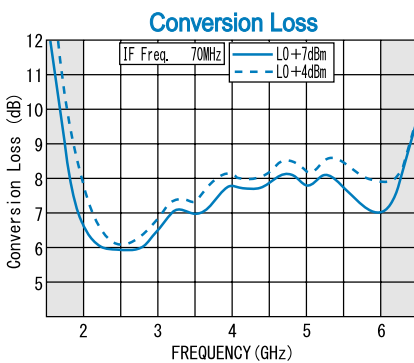

SCHEMATIC

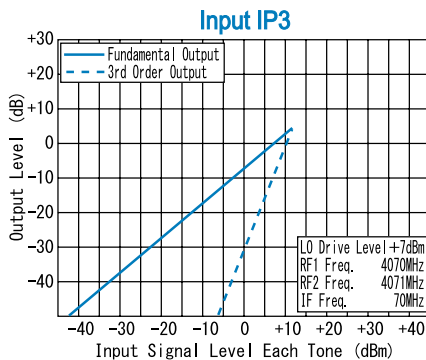
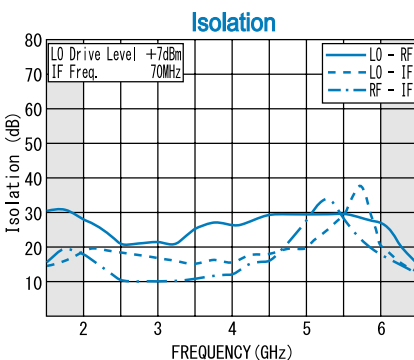
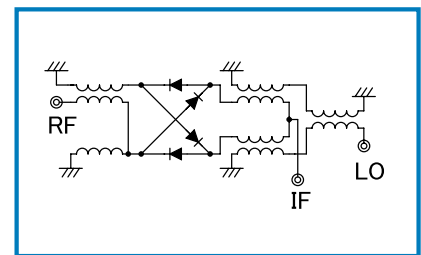

R&K reserves the right to make changes in the specifications of or discontinue products at any time without notice. R&K products shall not be used for or in connection with equipment that requires an extremely high level of reliability and safety such as aerospace uses or medical life support equipment. Further, R&K cannot export products to any country for use in military or defense applications.

R&K Company Limited

721-1 Maeda, Fuji-City, Shizuoka-Pref. 416-8577 Japan
 Tel : +81-545-31-2600 E-mail : info@rkco.jp
 Fax : +81-545-31-1600 URL : http://rk-microwave.com