

# RF POWER AMPLIFIER



## R&K-GA00237-2737-M



### OUTLINE DRAWING

※ IN MILLIMETERS

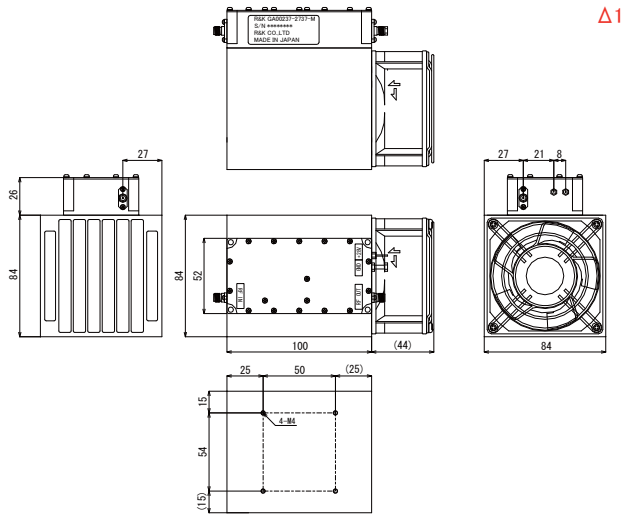

- Broadband Frequency: 20MHz~3700MHz
- Output Power : 5W (typ.) @Psat.
- Gain Flatness : ±2.0dB (max.)

### SPECIFICATIONS @ +25°C

Frequency Range	: 20MHz ~ 3700MHz
Small Signal Gain	: +27.0dB (typ.) : +25.0dB (min.)
Gain Flatness	: ±2.0dB (max.)
Output Power	: 1W (min.) @1dB Comp. : 2W (min.) @3dB Comp. : 5W (typ.) @Psat.
Output I.C.P.	: +42.0dBm (typ.)
Noise Figure	: 12.0dB (max.)
Impedance	: 50Ω
Input Return Loss	: -8.0 (max.)
Output Return Loss	: -2.0 (max.)
Maximum RF Input Power	: +15.0dBm
Maximum RF Output Power	: +38.0dBm
DC Supply Input	: +28V ± 3% : 1.2A (max.)
Operating Temperature (@Base Plate temp.)	: -10°C to +50°C
Storage Temperature	: -15°C to +65°C
Connectors	: RF - IN SMA - FEMALE : RF - OUT SMA - FEMALE
Size	: (W)84mm×(D)144mm×(H)110mm
Weight	: 220g (typ.)

### HOW TO ORDER

Model Name  
R&K-GA00237-2737-M

No Option

### TYPICAL PERFORMANCE (Temp @+25°C)

#### Small Signal Gain & Gain Flatness

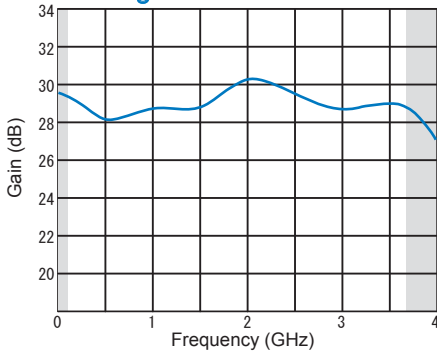

#### Input / Output Return Loss

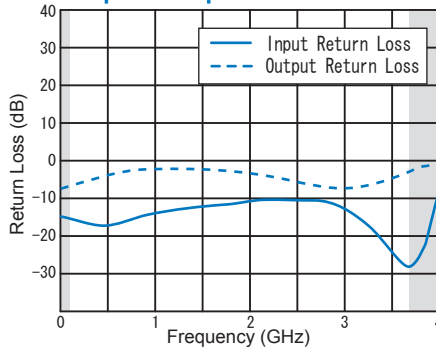

#### SCHEMATIC

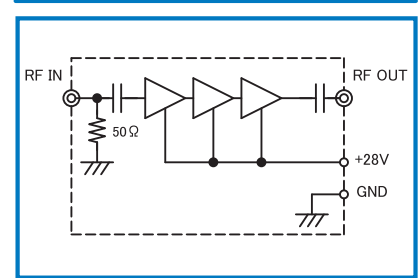

#### Output Power 1dB & 3dB Gain Comp.

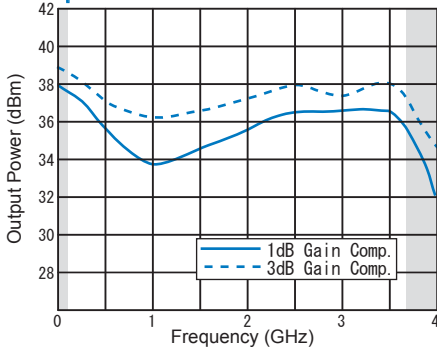

#### Noise Figure

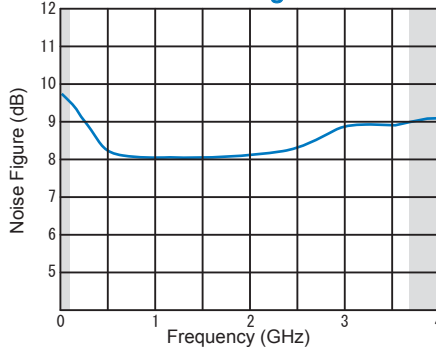

#### Output Power Linearity

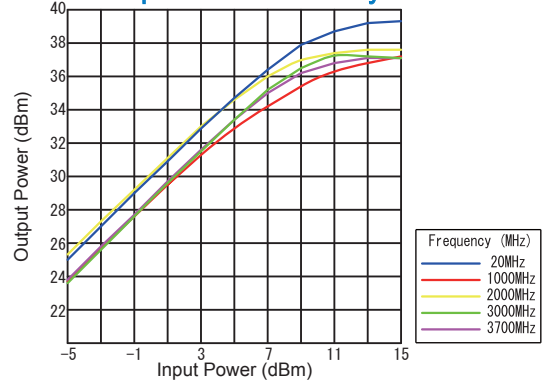

\*CHANGE Δ1 17/05/2013

R&K reserves the right to make changes in the specifications of or discontinue products at any time without notice. R&K products shall not be used for or in connection with equipment that requires an extremely high level of reliability and safety such as aerospace uses or medical life support equipment. Further, R&K cannot export products to any country for use in military or defense applications.

## R&K Company Limited

721-1 Maeda, Fuji-City, Shizuoka-Pref. 416-8577 Japan  
Tel: +81-545-31-2600 E-mail: info@rkco.jp  
Fax: +81-545-31-1600 URL: http://rk-microwave.com