

DOUBLE BALANCED MIXER

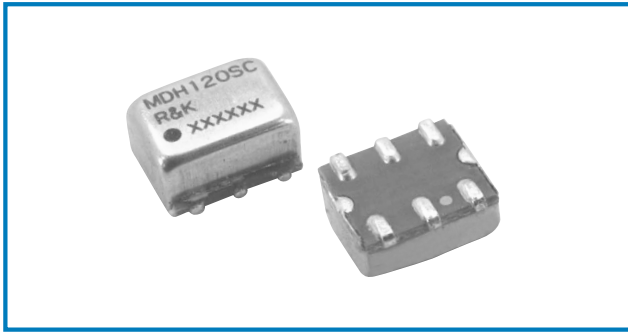

R&K-MDH120



OUTLINE DRAWING

※ IN MILLIMETERS

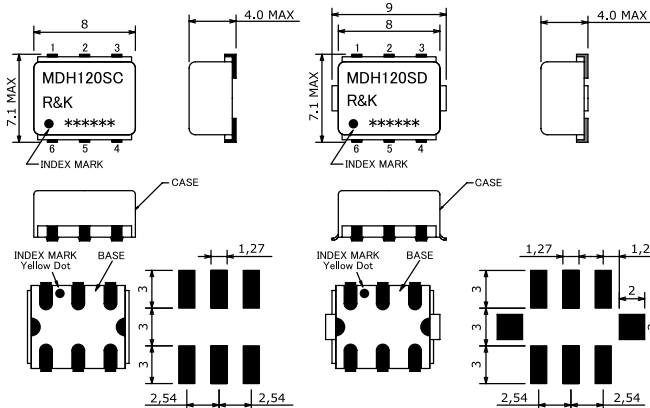

MDH120SC

MDH120SD

- Frequency : DC-3200MHz
- High LO Drive Level : +15dBm
- Small & Low Cost / Surface Mount
- RoHS Compliance

SPECIFICATIONS

Frequency Range [LO&RF] : 1400-3200MHz
 [IF] : DC-500MHz

Conversion Loss (LO Drive Level +15dBm)

	1400 - 2000MHz	2000 - 2700MHz	2700 - 3200MHz
Typ.	7.5dB	8.0dB	8.5dB
Max.	10.0dB	10.0dB	10.5dB

Isolation (min.)

	1400 - 2000MHz	2000 - 2700MHz	2700 - 3200MHz
LO - RF	20dB	20dB	20dB
LO - IF	15dB	20dB	25dB
RF - IF	5dB	10dB	10dB

- Input IP3 @Center Band : +20dBm (typ.)
- Input 1dB Comp. Point : +3dBm (typ.)
- Impedance (All Ports) : 50Ω
- Maximum RF Input Power : 200mW
- Maximum Peak IF Current : 50mA
- Operating Temperature : -40°C to +85°C
- Storage Temperature : -40°C to +100°C
- Max.Reflow Soldering Temp. : 260°C, 10sec.
- Reflow Soldering Repeatability : 3 times
- Weight (Standard) : 0.46g (typ.)

HOW TO ORDER

Model Name
R&K-MDH120SC-BLK BLK=Antistatic bag
TR1=Tape & Reel Package
SC=Case Type of SC
SD=Case Type of SD

TYPICAL PERFORMANCE (Temp @+25°C)

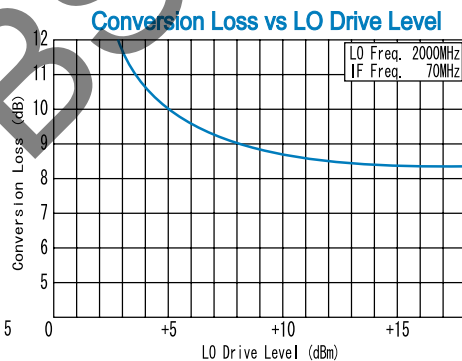
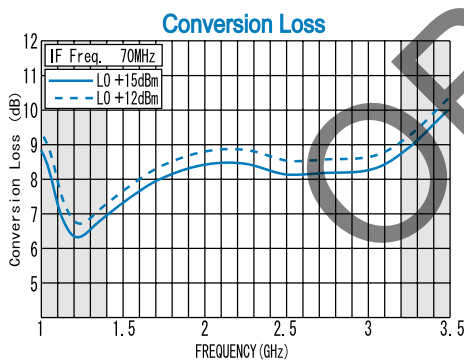

SCHEMATIC

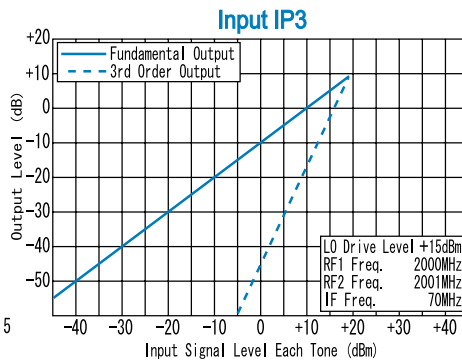
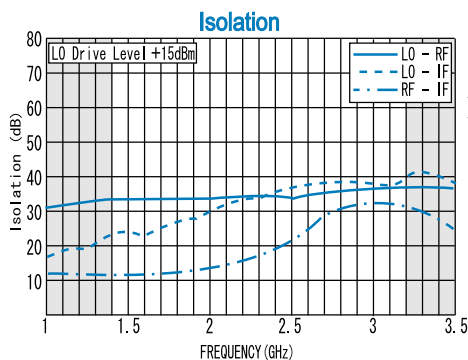
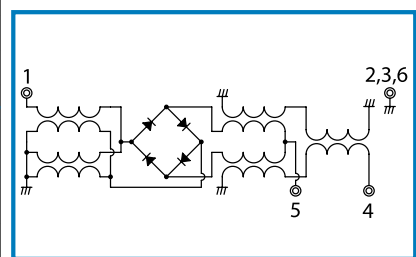

Function	Pin No.
LO	1
RF	4
I F	5
GND	2, 3, 6

R&K reserves the right to make changes in the specifications of or discontinue products at any time without notice. R&K products shall not be used for or in connection with equipment that requires an extremely high level of reliability and safety such as aerospace uses or medical life support equipment. Further, R&K cannot export products to any country for use in military or defense applications.

R&K Company Limited

721-1 Maeda, Fuji-City, Shizuoka-Pref. 416-8577 Japan
 Tel : +81-545-31-2600 E-mail : info@rk.co.jp
 Fax : +81-545-31-1600 URL : http://rk-microwave.com