

DOUBLE BALANCED MIXER

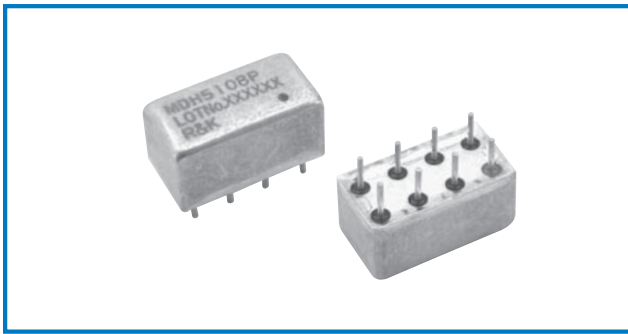

R&K-MDH510



OUTLINE DRAWING

※ IN MILLIMETERS

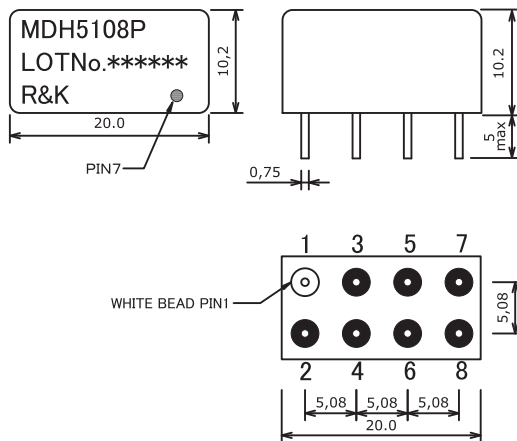

- Frequency : DC-1000MHz
- High LO Drive Level : +17dBm
- Low Cost / 8PIN Package
- RoHS Compliance

SPECIFICATIONS

Frequency Range [LO&RF] : 1-1000MHz

[IF] : DC-1000MHz

Conversion Loss (LO Drive Level +17dBm)

	1 - 50MHz	50 - 200MHz	200 - 1000MHz
Typ.	6.0dB	6.0dB	8.0dB
Max.	8.5dB	8.0dB	10.0dB

Isolation (min.)

	1 - 50MHz	50 - 200MHz	200 - 1000MHz
LO - RF	45dB	35dB	25dB
LO - IF	35dB	30dB	15dB
RF - IF	25dB	20dB	10dB

Input IP3 @Center Band : +18dBm (typ.)

Input 1dB Comp. Point : +8dBm (typ.)

Impedance (All Ports) : 50Ω

Maximum RF Input Power : 200mW

Maximum Peak IF Current : 100mA

Operating Temperature : -40°C to +85°C

Storage Temperature : -40°C to +100°C

HOW TO ORDER

Model Name

R&K-MDH5108P

8P=8PIN Package

TYPICAL PERFORMANCE (Temp @+25°C)

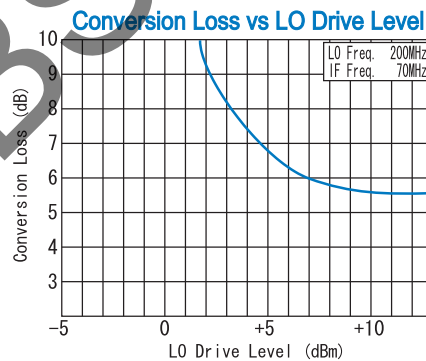
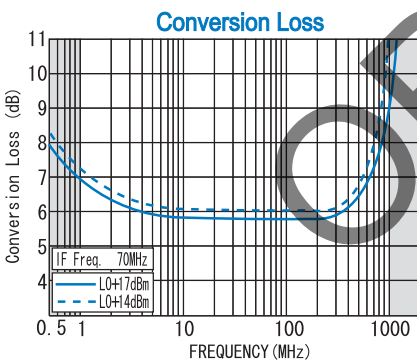

SCHEMATIC

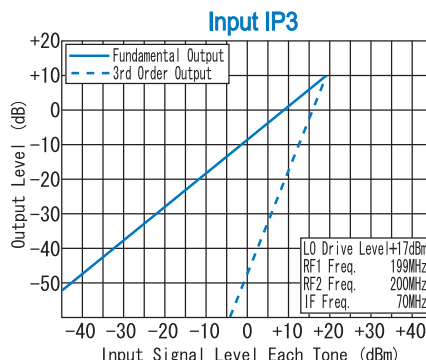
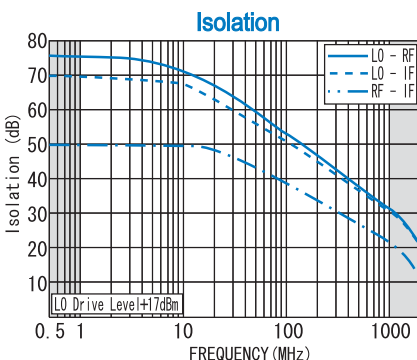
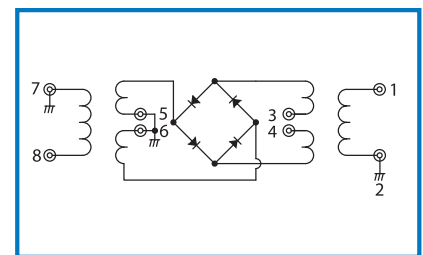

Function	Pin No.
RF	1
IF	3, 4
LO	8
GND	2, 5, 6, 7

R&K reserves the right to make changes in the specifications of or discontinue products at any time without notice. R&K products shall not be used for or in connection with equipment that requires an extremely high level of reliability and safety such as aerospace uses or medical life support equipment. Further, R&K cannot export products to any country for use in military or defense applications.

R&K Company Limited

721-1 Maeda, Fuji-City, Shizuoka-Pref. 416-8577 Japan
 Tel : +81-545-31-2600 E-mail : info@rkco.jp
 Fax : +81-545-31-1600 URL : http://rk-microwave.com