

# DOUBLE BALANCED MIXER

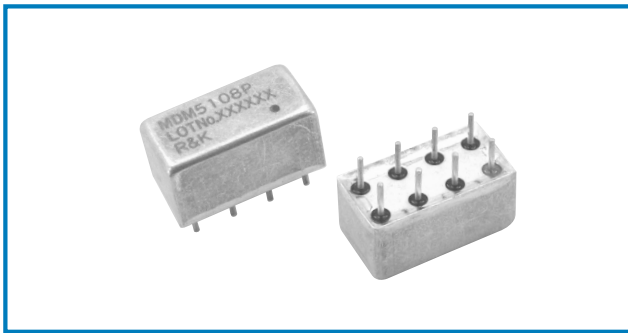

## R&K-MDM510



### OUTLINE DRAWING

※ IN MILLIMETERS

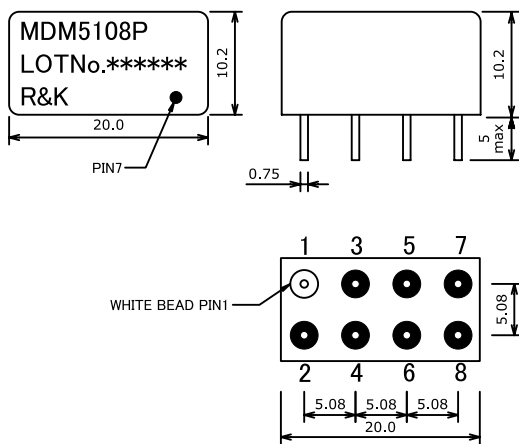

- Frequency : DC-500MHz
- Mid LO Drive Level : +10dBm
- Low Cost / 8PIN Package
- RoHS Compliance

### SPECIFICATIONS

Frequency Range [LO&RF] : 0.5-500MHz  
[IF] : DC-500MHz

Conversion Loss (LO Drive Level +10dBm)

	0.5 - 50MHz	50 - 200MHz	200 - 500MHz
Typ.	7.5dB	6.0dB	6.5dB
Max.	10.0dB	8.0dB	8.5dB

Isolation (min.)

	0.5 - 50MHz	50 - 200MHz	200 - 500MHz
LO - RF	40dB	30dB	25dB
LO - IF	35dB	30dB	20dB
RF - IF	25dB	20dB	10dB

- Input IP3 @Center Band : +18dBm (typ.)
- Input 1dB Comp. Point : +6dBm (typ.)
- Impedance (All Ports) : 50Ω
- Maximum RF Input Power : 200mW
- Maximum Peak IF Current : 50mA
- Operating Temperature : -40°C to +85°C
- Storage Temperature : -40°C to +100°C

### HOW TO ORDER

Model Name  
R&K-MDM5108P 8P=8PIN Package

### TYPICAL PERFORMANCE (Temp @+25°C)

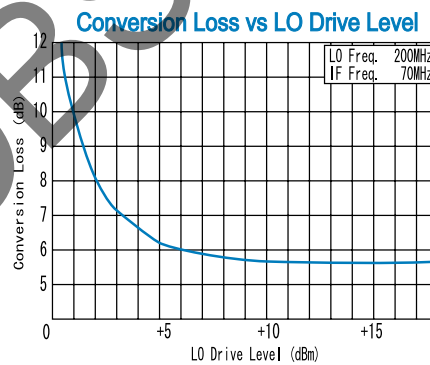
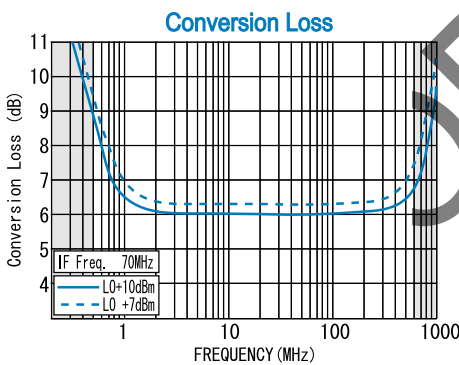

### SCHEMATIC

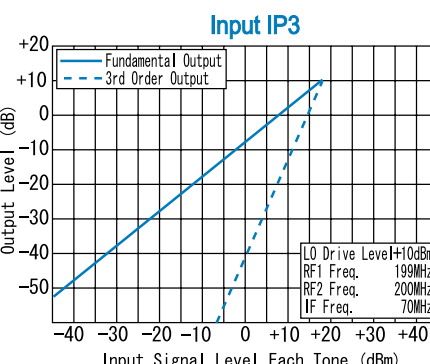
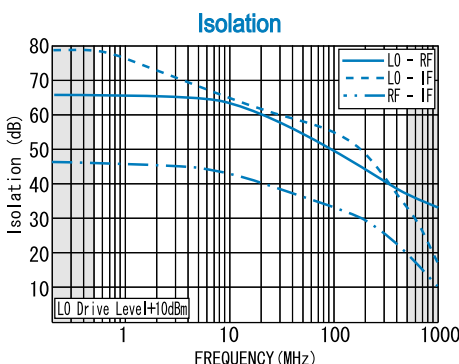
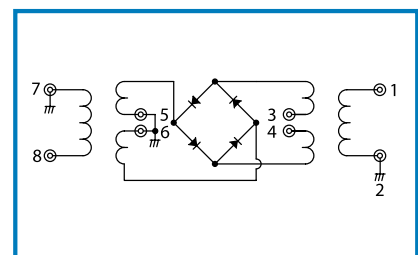

Function	Pin No.
RF	1
IF	3, 4
LO	8
GND	2, 5, 6, 7

R&K reserves the right to make changes in the specifications of or discontinue products at any time without notice. R&K products shall not be used for or in connection with equipment that requires an extremely high level of reliability and safety such as aerospace uses or medical life support equipment. Further, R&K cannot export products to any country for use in military or defense applications.

## R&K Company Limited

721-1 Maeda, Fuji-City, Shizuoka-Pref. 416-8577 Japan  
Tel: +81-545-31-2600 E-mail: info@rk.co.jp  
Fax: +81-545-31-1600 URL: http://rk-microwave.com