

DOUBLE BALANCED MIXER

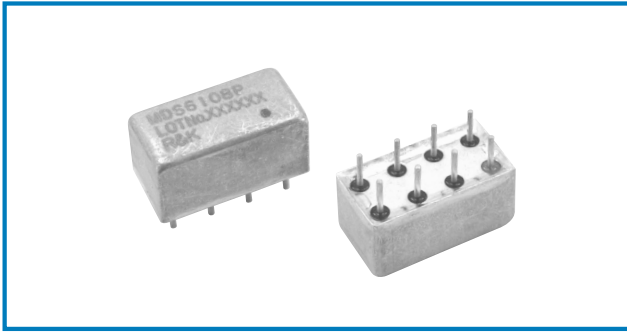

R&K-MDS610



OUTLINE DRAWING

※IN MILLIMETERS

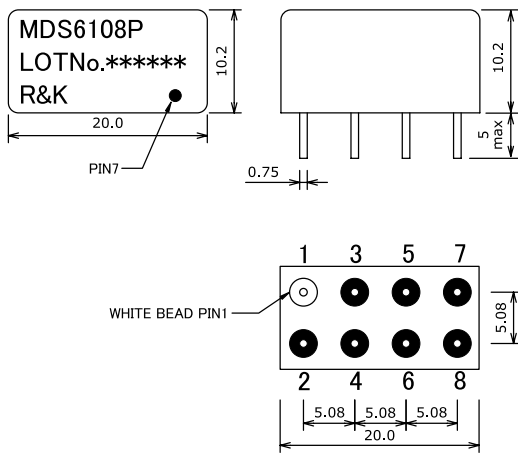

- Frequency : DC-1000MHz
- S-High LO Drive Level : +23dBm
- Low Cost / 8PIN Package
- RoHS Compliance

SPECIFICATIONS

Frequency Range [LO&RF]	: 1-1000MHz		
[IF]	: DC-1000MHz		
Conversion Loss (LO Drive Level +23dBm)			
	1 - 50MHz	50 - 200MHz	200 - 1000MHz
Typ.	8.0dB	7.0dB	8.0dB
Max.	10.5dB	9.0dB	10.0dB

Isolation (min.)

	1 - 50MHz	50 - 200MHz	200 - 1000MHz
LO - RF	45dB	40dB	30dB
LO - IF	40dB	30dB	20dB
RF - IF	30dB	20dB	15dB

- Input IP3 @Center Band : +25dBm (typ.)
- Input 1dB Comp. Point : +15dBm (typ.)
- Impedance (All Ports) : 50Ω
- Maximum RF Input Power : 1000mW
- Maximum Peak IF Current : 50mA
- Operating Temperature : -40°C to + 85°C
- Storage Temperature : -40°C to +100°C

HOW TO ORDER

Model Name
R&K-MDS6108P 8P=8PIN Package

TYPICAL PERFORMANCE (Temp @+25°C)

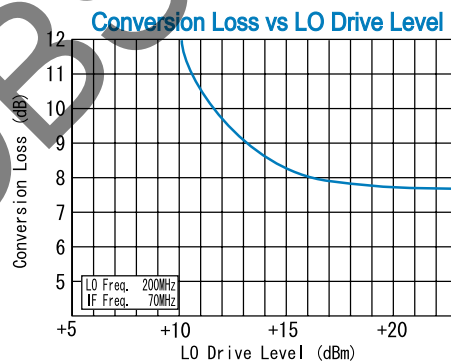
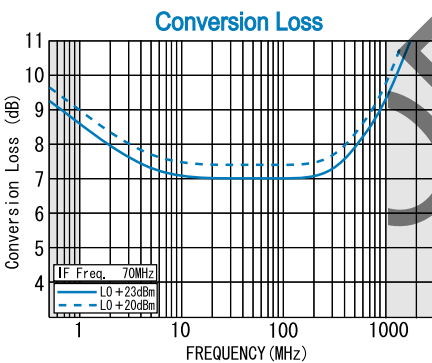

SCHEMATIC

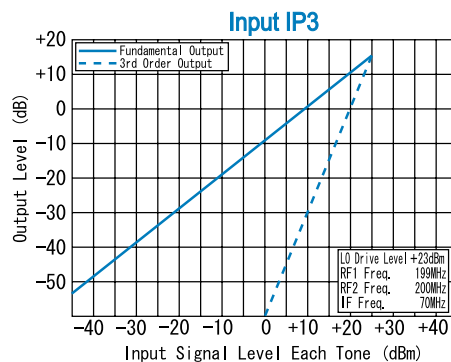
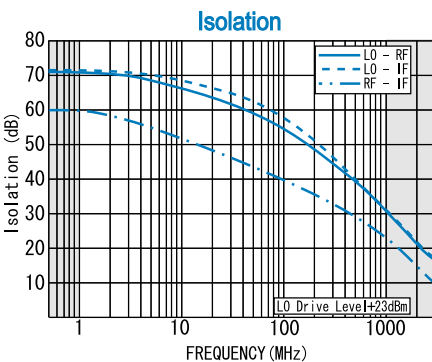
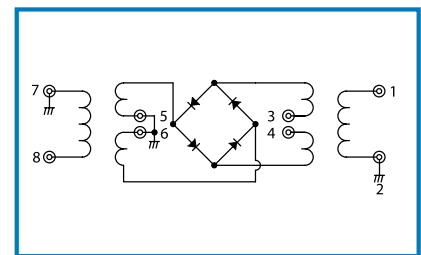

Function	Pin No.
RF	1
IF	3, 4
LO	8
GND	2, 5, 6, 7

R&K reserves the right to make changes in the specifications of or discontinue products at any time without notice. R&K products shall not be used for or in connection with equipment that requires an extremely high level of reliability and safety such as aerospace uses or medical life support equipment. Further, R&K cannot export products to any country for use in military or defense applications.

R&K Company Limited

721-1 Maeda, Fuji-City, Shizuoka-Pref. 416-8577 Japan
Tel: +81-545-31-2600 E-mail: info@rkco.jp
Fax: +81-545-31-1600 URL: http://rk-microwave.com